

supplyLAB

Cacém Park - Edifício 9
Estrada de Paço de Arcos nº88
2739-512 Agualva Cacém

www.supplylab.pt
geral@supplylab.pt

T +(351) 21 4278700
F +(351) 21 4278709

Vötsch
Industrietechnik

Product-friendly and fast . . .



. . . Vacuum Heating and Drying Ovens VVT
Optimum drying results under exceptional conditions

Drying in a vacuum . . .

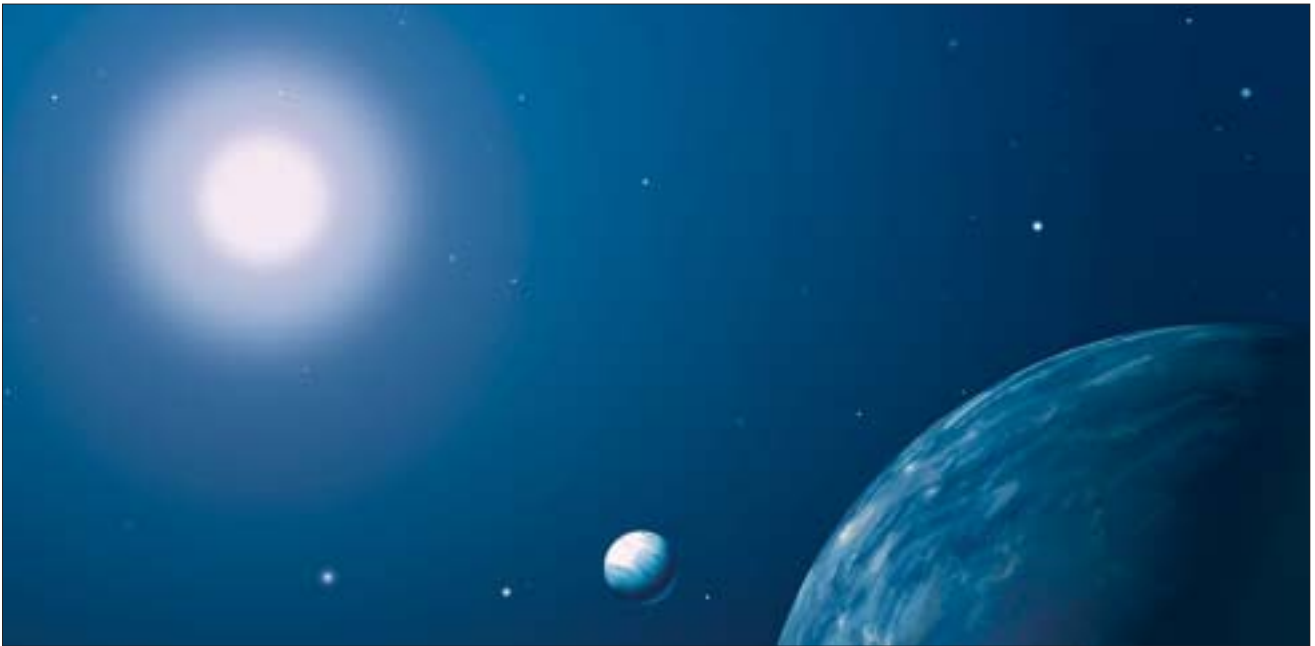

The Advantages

No doubt, there are various ways of drying your product. You should decide on the vacuum drying ovens VVT of Vötsch . . .

- Heat-sensitive mediums (e. g. pharmaceutical products) are dried with care
- Reduced drying times by lowering the pressure
- Due to the extremely low remaining oxygen content in the drying oven there are no oxidation processes
- Evaporating fluids (e. g. solvents) can be recovered
- Optimum drying conditions for light, powdery products as there is no turbulence (no convection)
- No “skin-forming” on the product being dried; therefore constant drying performance
- Economic because steam or warm water from other processes can be used as a heat medium
- Flexible heating.

Graph showing state of water

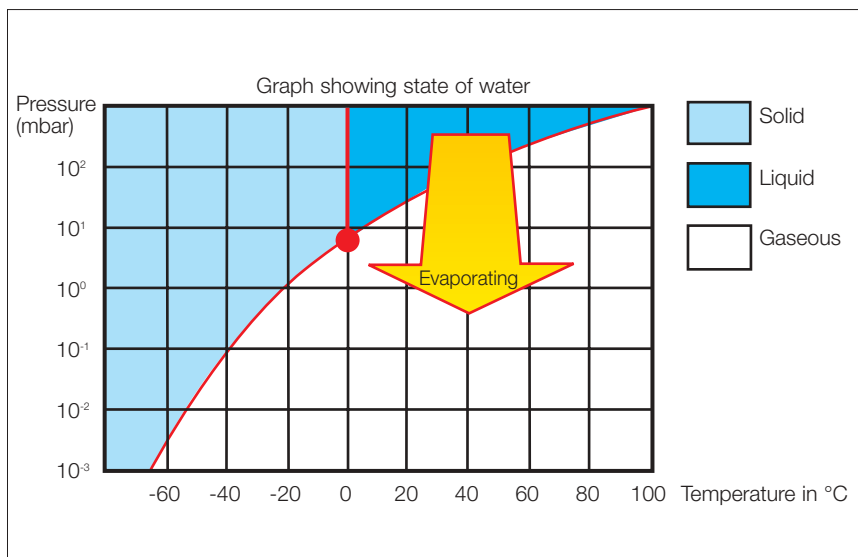

... more multi-faceted than you think

Range of Application

You can dry products from almost all branches of industry in a vacuum drying oven, e. g.:

- Pharmaceutical industry
- Chemical industry
- Cosmetics industry
- Food processing industry
- Electrical and electronic engineering
- Precision engineering and optics
- Aerospace industry
- Research and development
- Microstructure techniques
- Nanotechniques
- Plastics and ceramics
- Textiles
- Surface techniques

State your special requirements – we will carry out preliminary experiments for you.

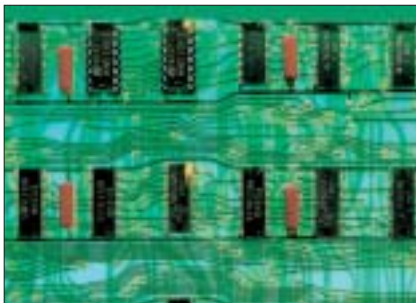

Construction . . .

Design

Our vacuum drying ovens are of compact design. The major components are:

- Drying oven with shelves
- Heating and cooling aggregate for the thermal medium
- Vacuum pump
- Condenser with storage vessel.

Heating Modes

- Electrical
- Warm water
- Thermal oil
- Steam
- Infrared radiation
- Microwave (HF)

Testing

We seal test our vacuum drying ovens and supply you with a test certificate.

Safety Devices

- Pressure-relief valve
- Temperature limiter

Construction Features

All components of the drying oven itself are of stainless steel with material class 1.4571 as these may come into contact with the product.

The external housing and reinforcements are made of stainless steel with the material class 1.4301.

- The interior of the drying oven is designed in compliance with **GMP-/FDA** regulations. This is **important** when the product being dried should on no account react to other substances or when product entrainment shall be prevented during loading/unloading.
- Inspection glass (200 mm diameter) in the door
- Heat-resistant silicon seal in the door
- Seals can be easily replaced when necessary
- Double-jointed hinge to ensure that the door closes tightly and prevents overwearing the seals
- Additional flanges are provided for special applications.

Temperature Range

The maximum rated temperatures that can be reached at the product being dried depend on the mode of heating used for the drying oven.

Mode of Heating	Maximum Temperature in °C
Electric	200 / 400
Warm water	95 / 140
Thermal oil	200 / 250
Steam	according to the steam pressure

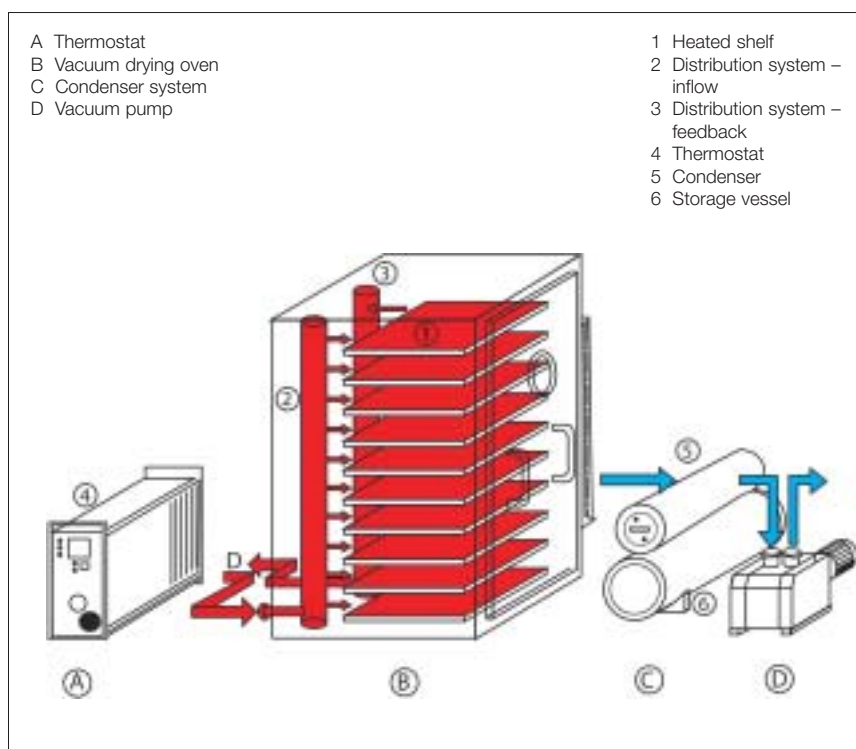

Vacuum Heating and Drying Ovens WT 125/170 WW-GMP

Heating Modes

We offer four heating solutions:

- Electrical
- With heating medium
- Infrared radiation
- Microwave (HF).

The first two processes are based on the principle of contact heating. This means that the heat is conducted from the heat medium through contact areas to the product.

With the **electrical** version, tubular heaters are fed in coils through the hollow shelves (sandwich construction).

With the version using **heat medium** you have three possibilities:

- Warm water
- Thermal oil
- Steam.

If you wish to heat using a heat medium, we equip the drying oven with pressure-tight, hollow shelves. The difference from the electrical version is that the heat transfer medium flows through channels and then fills the entire cavity of the shelf.

A **separate thermostat** controls the temperature of the heat medium. The heated medium is pumped in a cycle through the individual shelves.

With the **steam** heating version a special valve is responsible for controlling the amount of steam. This control operates without auxiliary power so that it is possible to use this type of control in an explosion-proof room.

With steam it is possible to heat in two different ways, the temperature of the steam being important:

- When $T < 100\text{ }^{\circ}\text{C}$ the steam is routed into a heat exchanger where the heat energy of the steam is transferred to the water. The heated water is pumped through the shelves.
- When $T > 100\text{ }^{\circ}\text{C}$ the steam is fed into the distribution system for the shelves.



Vacuum Heating and Drying Oven VVT 110/170 EA (jacket heating)

Vacuum Pump

A standard feature of our vacuum drying ovens are the oil-sealed, slide vane rotary vacuum pumps.

Condenser

The condenser enables large amounts of humidity to be recovered which is particularly important when using hazardous solvents.

An additional advantage: condensation accelerates drying.

Use with potentially explosive products and in hazardous locations

Our vacuum drying ovens are explosion-protected when ...

- the vacuum drying oven is to be installed in an area where there is risk of explosion
- the fluid of your product being dried is easily inflammable.



Options/Accessories

- Use of special materials for all components that come into contact with evaporating fluids (e.g. Inconel, Hasteloy)
- Combination with recirculation air for heating up of products at normal atmosphere
- Design in accordance with **GMP-/FDA**
- Qualification documents are issued as verification of our tests
- In order to avoid condensation in the drying oven, the door and walls can be heated
- Pneumatically-controlled doors for the automatic loading of the drying oven
- Designed for high-vacuum processes
- Special dimensions
- Special vacuum pumps
- **SIMPATI*** Software (refer to page 6)
- Digital pressure display
- Pressure control in conjunction with a solenoid valve in the suction line
- Temperature sensor for product being dried
- Nitrogen supply for quick extraction of released vapour
- For aggressive solvents: door seals of viton or with FEP cover
- External housing with surrounding frame for installation in wall.

Operating and controlling . . .

Operating and controlling with SIMCON/32*-NET...

All Vötsch dry heat sterilisers are equipped with the operating and control system SIMCON/32*-NET.

The SIMCON/32*-NET is a self-controlling, digital measuring and control system. The input of process parameters and programmes, as well as the output of actual values, operating and error messages, is carried out by means of a touch-panel.

- Comfortable input of process values and programme operation, with graphic presentation of the set and actual values by means of the touch-panel
- Programme memory for up to 100 programmes, with a total of 1,000 sections
- Two-level password protection against unauthorised access
- Integrated limit value temperature control system
- Serial interfaces RS 232 C and RS 485, Ethernet
- Operating and failure messages are shown on the colour touch-panel
- Compatible with Vötsch PC software package SIMPATI*, for convenient administration and archiving data records
- Special user interface for application in a production environment (simplified process start/stop mode).

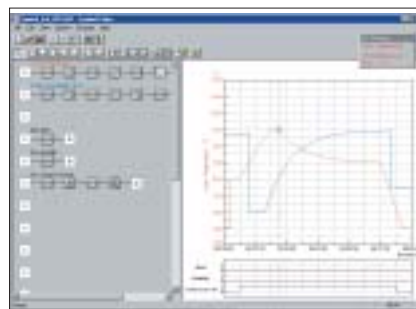

Vötsch PC software package SIMPATI*

The Vötsch software SIMPATI* ensures a complete documentation and graphical evaluation

If installed in an optional notebook or PC, the user can create programme profiles and document all process parameters. Parallel to this, the user can make full use of the PC's performance.

Software advantages:

- Up to 99 units can be networked
- Programming and selection of programmes for automatic processes; no costly programming required
- Not only operating and control but also documentation, visualisation and administration of sterilisation process data
- Print graphical presentation of process data and copy into other programmes. Internal interfaces ensure compatibility (with Microsoft Word, Microsoft Paint, Microsoft Excel, National Instruments Labview)
- Access via PC network and your Internet browser
- Transfer of messages per e-mail to an available mail-server (SMTP)
- Reads programmes, production data (product, operator, unit) via bar code (optional)
- Conforms with FDA 21 CFR, part 11.



...the Technical Data

Series				VVT 65/50	VVT 65/85	VVT 85/85	VVT 85/110	VVT 85/170
Nominal temperature		°C		200	200	200	200	200
Internal dimensions	A	Width	mm	660	660	860	860	860
	B	Height	mm	550	850	850	1100	1700
		Depth	mm	735	735	1050	1050	1050
Volume		litre		260	418	758	980	1515
Shelves	Width	mm	650	650	850	850	850	
	Depth	mm	650	650	950	950	950	
Height above shelves ¹⁾		mm		130	130	130	120	130
No. of shelves (standard)				3	5	5	7	10
Available surface (standard)		m ²		1.25	2.10	4.00	5.60	8.00
No. of shelves (max.)				5	8	8	10	16
Available surface (max.)		m ²		2.10	3.30	6.40	8.00	12.90
External dimensions	D	Width	mm	1,140	1,140	1,340	1,340	1,080
	E	Height	mm	825	1,125	1,125	1,375	-
	H	Height	mm	1,450	1,750	1,750	2,000	2,000
		Depth	mm	1,115	1,115	1,430	1,430	1,430
Substructure height		G		625	625	625	625	-
Temperature distribution on the shelves		K		±3	±3	±4	±4	±4
Heating capacity		kW		3	5	10	14	20
Heating capacity with max. no. of shelves		kW		5	8	16	20	32
Power supply				← 3(N)/PE AC 400 V ±10 %, 50 Hz ³⁾ →				
Suction connections		DN		40 KF	40 KF	40 KF	65 ISO-K	65 ISO-K
+ small flange		DN		10 KF	10 KF	10 KF	10 KF	10 KF
Ultimate vacuum ²⁾		mbar		1 x 10 ⁻²	1 x 10 ⁻²	1 x 10 ⁻²	1 x 10 ⁻²	1 x 10 ⁻²
Weight, approx.		kg		800	950	1,300	1,500	1,900

¹⁾ With electrically heated shelves minus 5 mm.

²⁾ The ultimate vacuum depends on the type of pump used.

³⁾ Other voltages and frequencies as option.

We reserve the right to make technical alterations.

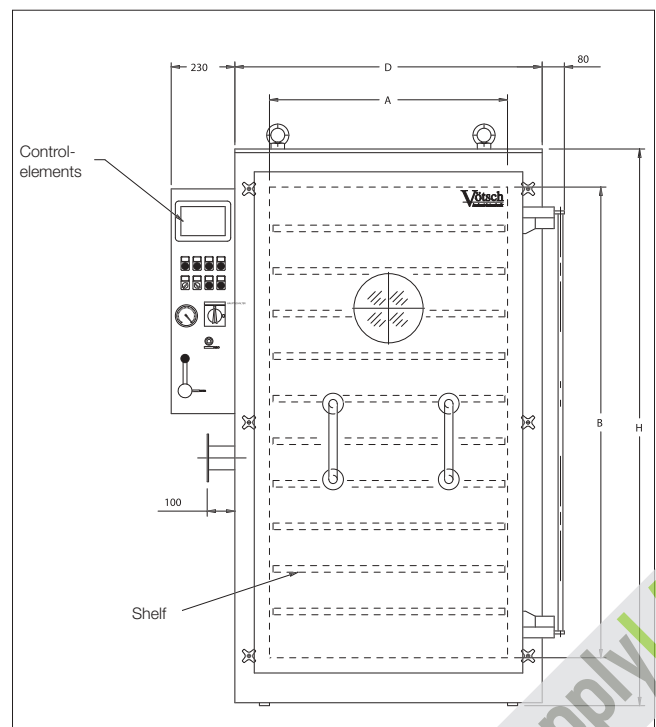
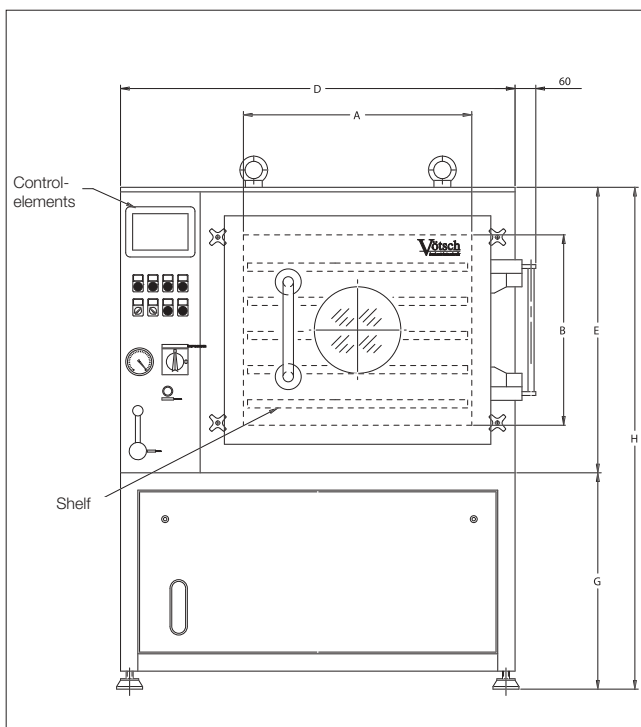

Standard and customised solutions...

Standard and customised solutions to your special applications

- Heating and drying cabinets
- Vacuum, heating and drying ovens
- Clean air, heating and drying ovens
- Explosion-proof drying ovens
- Tempering ovens up to 750 °C
- Chest ovens for easy top loading
- Drawer-type ovens
- Walk-in ovens and systems for continuous heating processes
- Hot air sterilisers for normal and clean air conditions
- Charging systems e. g. charging trolleys, transport trolleys and wire meshed shelves
- Heating options
Electrical, gas, infrared, microwave, warm water, steam, thermal oil
- For process documentation as per EN ISO 9001 we offer a variety of accessories and software for controlling, monitoring and documenting. Networking of up to 99 systems via one PC station.



Vacuum, heating and drying ovens VVTD 85/170/125 E-GMP

Competence and dedication to customers ...

- Individual consultation
- Engineering and development
- Production and assembly
- Commissioning and briefing
- Calibration in own laboratory
- Maintenance, spare parts service, repairs
- Recycling of redundant units
- Training and workshops

Further information and representatives world-wide see www.voetsch.info

supplyLAB

www.supplylab.pt
geral@supplylab.pt

Cacém Park - Edifício 9
Estrada de Paço de Arcos nº88
2739-512 Aqualva Cacém
T +(351) 21 4278700
F +(351) 21 4278709

Vötsch
Industrietechnik

Vötsch Industrietechnik GmbH
Umweltsimulation · Wärmetechnik

Product Range Heat Technology

Greizer Strasse 41-49
35447 Reiskirchen-Lindenstruth
Germany
Phone +49 (0) 64 08 / 84-73
Fax +49 (0) 64 08 / 84-87 47
info-wt@v-it.com
www.v-it.com · www.voetsch.info

CE

